

Bell Telephone System
Monograph B-944

Presented before
AMERICAN INSTITUTE OF ELECTRICAL ENGINEERS
NEW HAVEN, CONN. MAY, 1936

Published in
ELECTRICAL ENGINEERING
VOL. 55, PP. 773-783 JULY, 1936

COPYRIGHT, 1936, BY THE
AMERICAN INSTITUTE OF ELECTRICAL ENGINEERS

Printed in the United States of America

DIAL SWITCHING OF CONNECTICUT TOLL
CALLS

W. F. ROBB,* A. M. MILLARD,* G. M. McPHEE*
Associate A. I. E. E. Member A. I. E. E. Nonmember A. I. E. E.

THE dial switching, or dial tandem,¹ system for handling short distance toll calls may be described as an arrangement of step-by-step dial selector groups located at various centers about an area, connected with suitable trunk circuits to one another and to the switchboards and dial terminal equipments of the associated telephone exchanges. The operators at these switchboards actuate the selectors by dialing to complete calls from their subscribers to subscribers in other exchanges and thereby obtain a direct connection to the subscriber terminal in dial exchanges, or through operators at local switchboards in the manual exchanges. The connections may involve only one interexchange toll circuit unit, or they may require the end-to-end or tandem linking of 2 or more circuit units to establish the traffic path; the latter is made by the dial equipment without the assistance of intermediate operators. In addition, through supervision is given to the originating operator, the removal and replacement of the receiver of the called subscriber being shown by means of lamp signals.

The application of step-by-step dial equipment to the switching of toll calls is of rather recent origin, having been introduced for the first time on any considerable scale in 1926 in the territory in and about Los Angeles, Calif.²

In Connecticut, telephone subscribers served by manual switchboards are requested to give all station-to-station toll calls to the local operators, and all person-to-person calls to the toll operators. The local operators complete these calls over the tandem system where possible, or over direct ring-down trunks to other local switchboards. If no such routes are provided, the calls are passed to the

* All of The Southern New England Telephone Company, New Haven, Conn.

1. For all numbered references, see list at end of paper.

toll operator for handling over the toll ringdown circuit network. In dial areas, both station-to-station and person-to-person calls are given by the subscriber to a common group of operators located at toll type switchboards, who use the tandem system for completing all types of calls to the exchanges for which tandem routes are provided.

Dial tandem switching of toll traffic is particularly suitable in densely populated areas having a considerable amount of short distance toll traffic, and where much of this traffic terminates at dial subscriber stations. Conditions in Connecticut satisfy these essentials with an area of approximately 4,800 square miles and a population of more than 1,600,000 inhabitants reasonably well distributed over the territory. The greatest air line distance between telephone exchanges in the state barely exceeds 100 miles. In the 75 telephone exchanges operated by The Southern New England Telephone Company and independent connecting companies, about 66,000 out-of-town telephone messages destined for subscribers in Connecticut or certain near-by exchanges in adjoining states originate during every business day. At the present time 11 of these 75 exchanges are served by dial equipment of the step-by-step type, and the remainder is served by manual switchboards of various types. The dial equipment generally is found in the large exchanges, and it provides telephone service for approximately 57 per cent of the subscriber stations in the area. Only 5 of the 75 exchanges serve more than 10,000 telephone stations each, and the largest exchange (Hartford) serves less than 60,000 stations.

BACKGROUND

The introduction of the dial tandem method in Connecticut was not forced by the trunking problems commonly encountered in the larger metropolitan areas. It was introduced as an improvement in method, and was economically adopted at the time of general replacements accompanying an extensive program for dial conversion of manual telephones.

Comprehensive studies comparing the dial tandem switching plan for handling short distance toll traffic with the former ringdown circuit methods, and also with a plan involving the then relatively new straight-forward trunking equipment⁸ on a direct trunk basis, indicated service benefits and over-all savings favor-

(2)

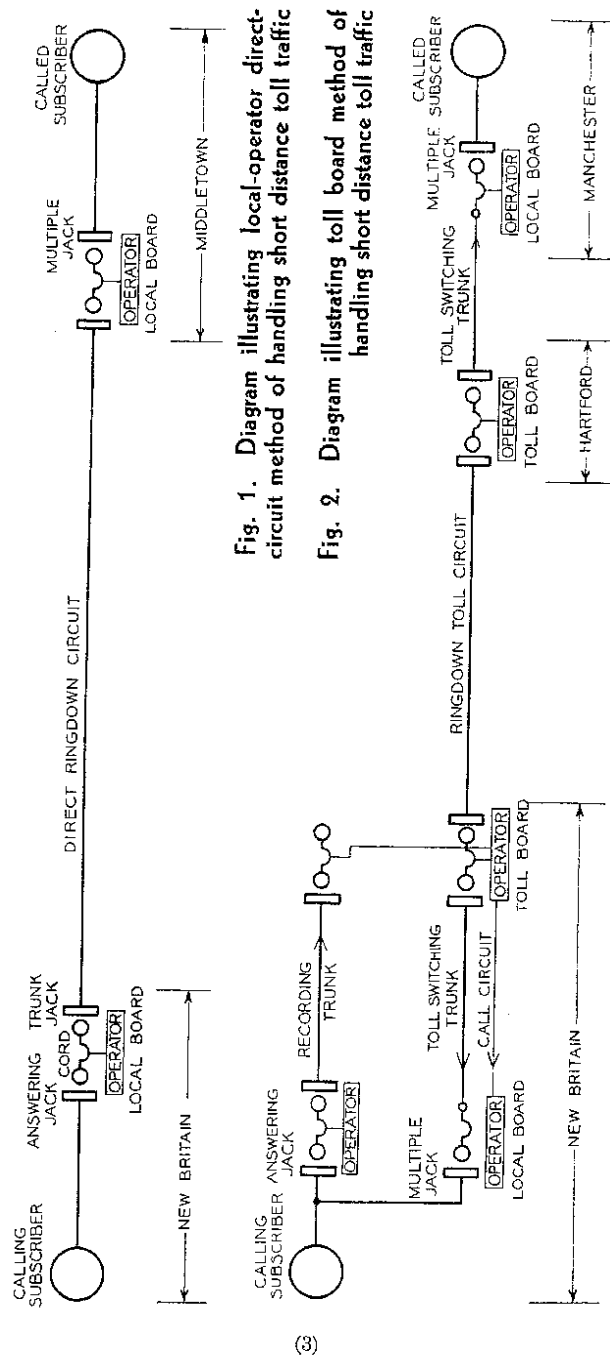

Fig. 1. Diagram illustrating local-operator direct-circuit method of handling short distance toll traffic

Fig. 2. Diagram illustrating toll board method of handling short distance toll traffic

ing the dial tandem plan. It was decided, therefore, to introduce this plan gradually as the larger exchanges were converted to dial operation.

Short distance toll traffic formerly was handled by 1 of 2 distinct methods. The first, or local-operator direct-circuit method, was used for station-to-station calls where the amount of traffic could justify direct circuit groups of the ringdown type between local switchboards of different exchanges. Before the introduction of the tandem system, approximately 78 per cent of the short distance toll traffic was handled by this method, which is shown in figure 1. In this typical case the local operator in New Britain (a manual exchange), on receiving a call for a subscriber station in Middletown (a manual exchange), connected the calling subscriber to one of the direct ringdown circuits to that local switchboard and signaled the Middletown operator by ringing. The New Britain operator passed the number of the called station to the Middletown operator, who completed the connection. Both operators received lamp signals from their subscribers denoting the end of conversation.

The second or toll board method was employed by toll operators for those station-to-station calls to exchanges to which the local operators had no direct circuits, and for person-to-person calls. In an example of one variation of this method, shown in figure 2, the New Britain local operator received a call from one of the local subscribers to Manchester, also a manual exchange, and dispatched it over a recording trunk to a New Britain toll operator, to whom the subscriber gave his own number and the number of the desired Manchester subscriber station. The New Britain toll operator, using a second cord, then plugged into an idle ringdown toll circuit to the Hartford toll board, which is the toll center for Manchester. The New Britain operator rang, and on answer of the Hartford toll operator, gave the desired Manchester station number. At the same time, over a call circuit, the New Britain toll operator requested an operator at another position of the New Britain local switchboard to plug an idle toll switching trunk into the multiple jack of the calling subscriber's line, and connected the second cord also to this trunk, both operators releasing the first connection to the recording trunk. The Hartford toll operator in the meantime connected the toll

(4)

Fig. 3. Diagram illustrating dial tandem method of handling short distance toll traffic

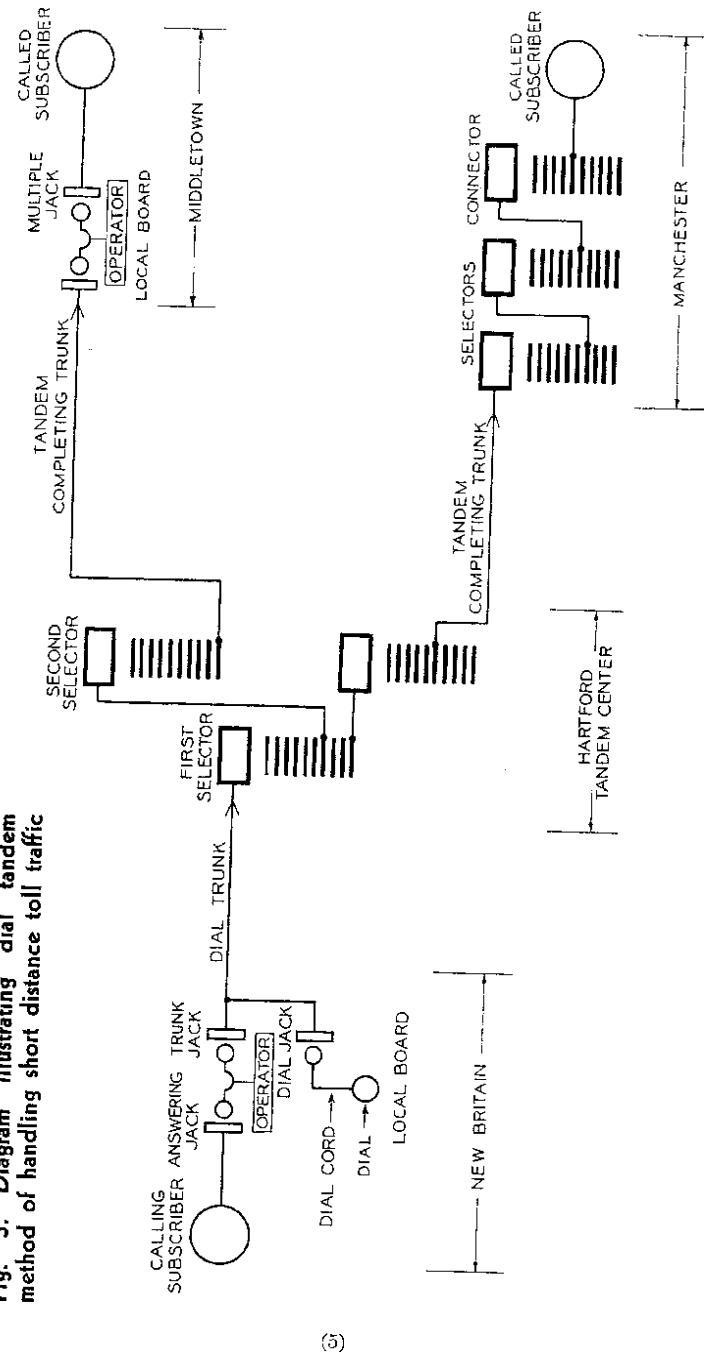

(5)

circuit through another toll switching trunk to the Manchester local switchboard, where a local operator completed the connection to the called subscriber's line, and the Hartford toll operator rang the called subscriber's station. It will be seen that 5 operators were required to establish this connection. In many cases direct circuits were not available between toll switchboards, thus requiring another operator at an intermediate toll switchboard to connect 2 toll circuits together for the traffic path and further complicating the establishment and discontinuance of the connection.

TANDEM NETWORK

The manner in which these connections are completed through the dial tandem network is indicated in figure 3. New Britain and Middletown remain manual exchanges, but Manchester has been converted to dial operation. The New Britain local operator answers a subscriber in the usual manner, receives a call for a Middletown station, and connects the subscriber to a trunk terminating at a selector in the Hartford tandem center. The New Britain operator then takes the single ended dial cord with which the position is equipped, plugs it into the dial jack associated with the trunk, and dials the digits 41, previously established as the code for Middletown. The tandem first selector¹ steps to the fourth level and is connected to a tandem second selector that steps to the first level and selects an idle trunk terminating in completing equipment of the jack ended straightforward type at the Middletown switchboard. The Middletown local operator receives a lamp signal when the trunk is seized, and answers with a local cord modified for tandem use, automatically sending an order tone to New Britain. The Middletown operator then receives the called number from the New Britain operator and completes the call to that subscriber's line, ringing the called station. The answer of the called subscriber extinguishes a lighted lamp associated with the New Britain operator's cord. The end of conversation is indicated by the lighting of both lamps associated with the New Britain operator's cord, and the connection automatically signaling the Middletown operator to disconnect her cord. A busy condition of the called

(6)

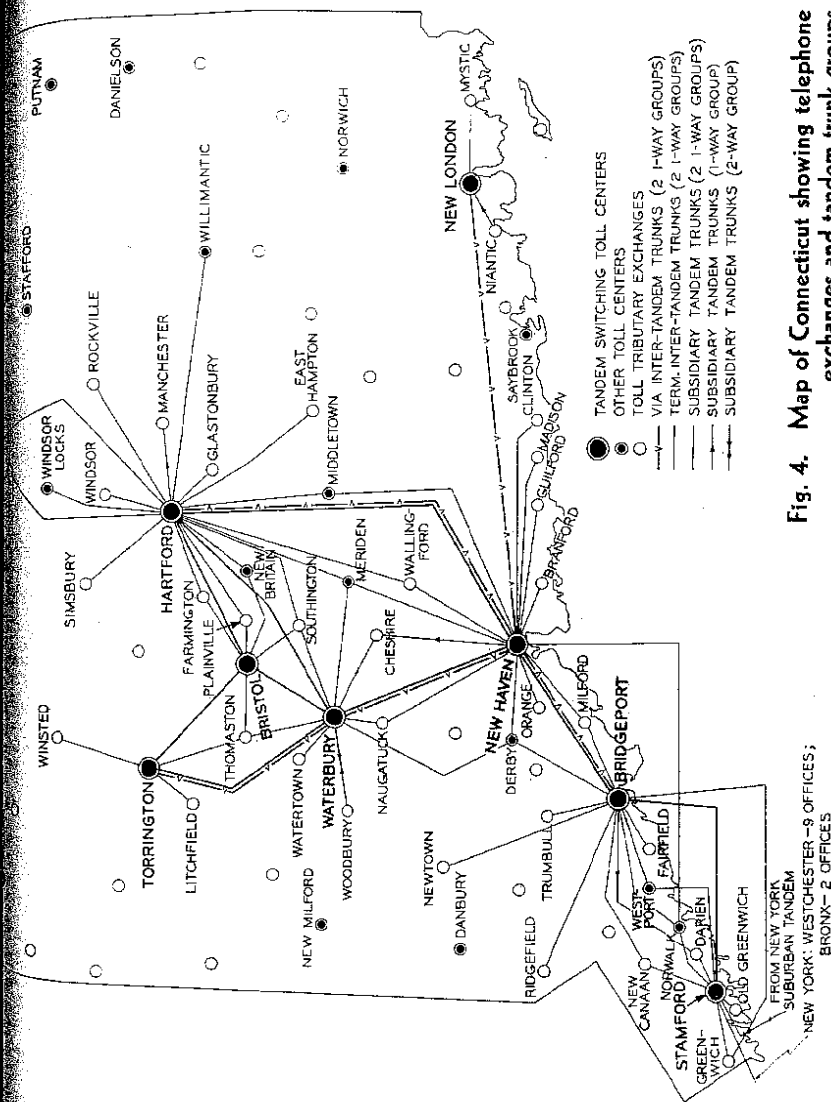

(7)

Fig. 4. Map of Connecticut showing telephone exchanges and tandem trunk groups

subscriber's line is indicated to the calling operator by a tone and visual flashing signal. The number of operators (2) involved in this call is the same as under the previous local-operator direct-circuit method, but circuit economies have been realized by the discontinuance of the New Britain-Middletown direct circuit group.

If the call had been for a subscriber in the Manchester dial office, the procedure would have been the same, except that the New Britain operator would have dialed the code 15 to select a trunk to the Manchester office, followed by the digits of the subscriber's number, in this case 15-4567, and the dial equipment would have completed the connection with only one operator having been involved. A lamp associated with the New Britain operator's cord would be extinguished when the Manchester subscriber answered, and both cord lamps would be lighted again at the end of conversation. A busy condition would be indicated to the New Britain operator by a tone signal and a flashing cord lamp.

The opportunities afforded for faster and somewhat more accurate service and improved economy of operation by the dial tandem method in comparison with the local operator direct circuit and toll board methods may be perceived readily.

The present scope of the Connecticut tandem system is shown in figures 4 and 5. Figure 4 shows all telephone exchanges in Connecticut and indicates the tandem switching toll centers, other toll centers, and the remaining local offices of the toll tributary class. Trunk circuit groups of the tandem system are shown. It should be noticed that in many instances the tandem centers are connected by groups of trunk circuits of 2 grades, that is, terminal and "via," the terminal grade being used for the shorter calls, and the "via" grade being used for those longer calls for which transmission considerations require a low loss circuit. The principles controlling the use of these 2 grades of intertandem trunks will be developed later in this paper. It is expected that all exchanges in Connecticut eventually will be connected to the tandem system.

The dial selectors of the tandem network are located in dial equipped exchanges at natural switching points throughout the area, where indicated by junctions of the interexchange wire routes and the general pattern of toll traffic flow.

(8)

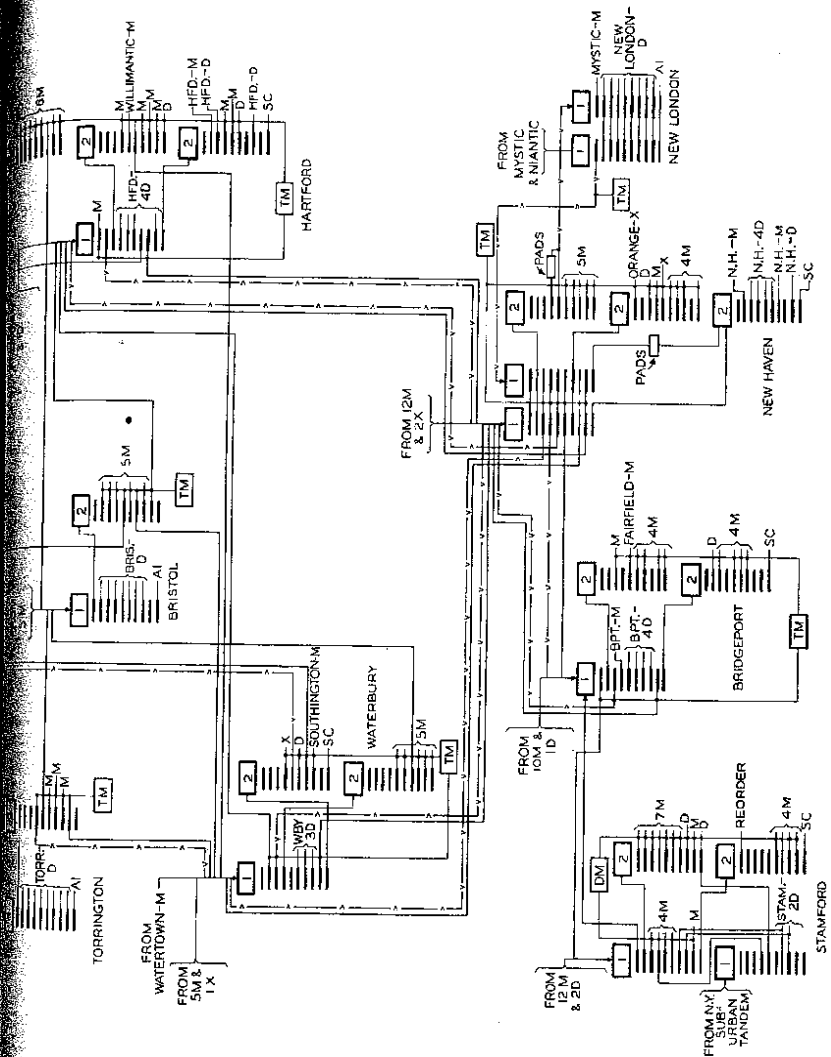

Fig. 5. Schematic diagram of entire dial tandem system in Connecticut

- | | | |
|--------------------------------|-----------------------------|------------------------------|
| 1—Step-by-step dial office | 2—Tandem second selector | SC—Service code selector |
| 1—Common battery manual office | TM—Toll board multiple | —v—"Via" intertandem groups |
| 1—Toll office | DM—Dial "A" board multiple | —Terminal intertandem groups |
| 1—Tandem first selector | A1—Auxiliary first selector | |

(9)

Figure 5 shows the entire tandem system, including the arrangements of the switching selectors in the tandem centers and the assignments of the levels of the switch banks to the various trunk groups. First and second selectors provide sufficient flexibility of codes for the offices of the system.

The following examples of codes assigned to the Watertown office associated with the Waterbury tandem center indicate the paths used for a few representative calls:

Watertown to	Code	Digits of Dial Subscriber's Number
Bristol.....	74	+ XXXX
Fairfield.....	8596	
New London.....	296	+ XXXX or 2-XXXX
Orange.....	240	
Rockville.....	948	
Southington.....	13	
Stamford.....	870	+ 3-XXXX or 4-XXXX
Willimantic.....	8686	

TRAFFIC CONSIDERATIONS

From the operating viewpoint, the dial tandem plan offers definite advantages of faster and somewhat more accurate service, and savings in operating effort.

The following is a summary of the Connecticut short distance toll traffic handled by the several operating methods, comparing the period just before the introduction of the dial tandem plan with the present extent of tandem operation:

Method of Handling	Per Cent of Short Distance Traffic Handled	
	Pretandem	Present Tandem
Local operator direct circuit.....	78	20
Toll board, ringdown circuit.....	22	10
Tandem, local and toll boards.....	0	70

In 1928, before the introduction of dial tandem handling, the indicated interval from the receipt of the calling subscriber's signal at the toll or local switchboard to the start of conversation averaged 70 seconds for all toll calls. This average included the longer and more involved out-of-state calls as

well as the short distance toll traffic. Under the present trunking arrangements this average interval has been reduced to 54 seconds. One important factor in this decrease is the direct handling by the local operators, over the tandem facilities, of much of the traffic that formerly required the toll board method; another is the use of the tandem facilities on much of the traffic handled at toll boards.

The theoretical speed of dial tandem operation, from the receipt of the calling subscriber's signal at the switchboard to the first ring on the called line, is 16 seconds for a call from a manual office to a subscriber in a connected dial office, and 20 seconds from a manual office to another manual office equipped with the cord ended straightforward type of tandem completing trunks. These intervals will vary slightly, depending on the number of digits of the tandem code. In applying these latter figures to actual traffic, it must be remembered that they do not include the time from the first ring on the called line to the answer of the called subscriber, which usually is an appreciable interval.

Greater accuracy is obtained by the reduction in the number of operators required in dispatching a call, with fewer possibilities for human error.

Marked savings in operating effort with the tandem plan are apparent from the comparison made earlier in this paper of the tandem operating method with the local-operator direct-circuit and toll board methods. Savings are realized particularly where calls formerly requiring toll board handling now can be handled by the originating operator over the tandem network, and where that operator can dial directly to a called subscriber terminal in a distant dial office.

The composite effect of tandem operation on the interexchange circuit network has been a slight increase in the number of circuit groups and also in the total number of circuits, assuming a common level of traffic. Various circuit economies have been possible with the tandem plan, but these have been overbalanced by the substitution of one-way tandem circuits, over which calls can be advanced in only one direction, for the former 2-way ringdown circuits. The one-way groups in the system are rather small, few exceeding 10 circuits and many having only 3 or 4; consequently, the requirements of these groups for the desired probability of available traffic paths

have resulted in the total of circuits in the 2 one-way groups between an office and the tandem center exceeding the circuits in the replaced 2-way group. Circuit terminal equipments providing for 2-way tandem operation are now under consideration, and they may be used more generally in the future. These equipments relatively would be more expensive than the one-way equipments, but their use might be justified particularly where the construction of addition interoffice wire facilities would otherwise be required for the one-way circuits.

The 2-way circuits may be used to supplement the one-way circuits between certain offices, arranged as last choice for the operators involved; the combination affords nearly the same efficiency of circuit usage that is possible with an all 2-way circuit plan.

Another factor increasing the circuits under the tandem plan has been the necessity for providing paths on a more liberal basis for the traffic formerly handled by the toll operators, but which now is completed directly by the local operators. Uniform handling of both out-of-town and local traffic by the local operators, involving the authorization of only one route to each called exchange, requires this more liberal circuit availability.

Circuit economies are found under the tandem plan in the elimination of most of the former direct circuit groups between local switchboards, and of many of the groups between toll switchboards, with the concentration of this traffic on the tandem circuits. Some direct circuit groups have been maintained between near-by local switchboards to avoid uneconomical "back hauling" of traffic. Many of the toll switchboard ringdown circuits between exchanges in the tandem area must be retained also, because toll operators in manual exchanges do not have access to the tandem network.

Other circuit groups discontinued under the tandem plan were those used for the handling of recording traffic from toll tributary offices to their toll centers, where the toll center is also a tandem center. This traffic now is handled over the dial circuits from the tributary office to the tandem center, and the local operator dials a special code to secure a connection from the tandem selectors to the recording operators at the toll board. These toll operators, however, still retain the usual toll switching trunk groups to their tributary offices. It

(12)

is not practicable to handle this toll switching traffic over the tandem completing trunk groups to the tributary offices, since the tandem circuits do not permit the operator to delay the start of ringing the calling subscriber as required on some calls, or to rering the subscriber.

A considerable reduction in nonproductive circuit holding time is possible with the tandem method, due to the speed with which the originating operator is able to establish even the more involved connections. The automatic release of the equipment following disconnection by the originating operator also effects a saving in circuit usage.

An advantage in administration of interoffice circuit loads is the flexibility that is possible in routing the longer calls over the intertandem groups having the greatest spare capacity, without increasing operating labor or slowing up the service. For example, the operator at the Watertown office, which is connected to the Waterbury tandem center, might dial Rockville through Hartford directly, through Bristol and Hartford, or through New Haven and Hartford, although only one route, the most satisfactory from traffic and transmission standpoints, is authorized. Sometimes it is possible to delay plant additions by rerouting traffic over other channels, if transmission considerations permit. Under emergency conditions, such as cable failure, tandem codes may be changed to allow operators to switch their calls through other tandem centers and so avoid the circuits in trouble.

A special development whereby outgoing trunks from the selectors of a particular tandem center are multiplied at the toll switchboard of that center enables the toll operators to complete calls to those trunks without dialing the one or 2 digits required of operators in the other offices. This has resulted in a saving of operating effort and some improvement in speed of service.

Dials are provided at all switchboards connected to the tandem system, except certain manual switchboards in the Westchester County area adjacent to the Stamford tandem center. Incoming circuits from these few exchanges to the Stamford tandem selectors also appear at the Stamford dial "A" board, where the operator is called upon to dial the tandem code (and the called number in the case of a dial office) and then drops out of the connection. The call then

(13)

is entirely under control of the originating manual operator. This is known as "intermediate dialing."

Very little difficulty has been experienced by operators in dialing the longer combinations of tandem code and dial subscriber numbers, although it is recognized that there may be a practical limit to the number of digits for efficient dialing.

Connections between 2 offices, one of which is not associated with the dial tandem system, are established by the direct circuit method where practicable; otherwise they are established by the toll board method. In no case has the manual connection of a tandem circuit to a nontandem circuit been authorized.

The equipment provisions of the tandem system will not permit the originating operator to recall the operator in a called manual office over the original connection. Where such a recall is required, the originating operator must establish a second connection to the called operator. The called operator can signal to the calling operator by using the flashing recorder circuit where it is provided, or with the flashing facilities of the supervisor's circuit.

TRANSMISSION CONSIDERATIONS

The transmission objective for these tandem connections is 23 decibels, which provides transmission of the standard obtaining in the usual very large multioffice exchange. This over-all limit is made up of the 2 tandem terminal losses plus the losses of the intertandem tie trunks. Tandem terminal loss is the sum of the attenuation loss from the tandem center to the outlying central office plus the average of the transmitting and receiving losses between that central office and the limiting subscriber in that exchange.

The intertandem tie trunks of the "via" grade are designed for an operating attenuation of 1.5 ± 0.5 decibels, using a terminal voice frequency repeater permanently associated with one end of each trunk, and 10 decibels is assigned for the tandem terminal loss. Normally only 2 intertandem tie trunks are allowed in any connection. As previously pointed out, these very high grade circuits are paralleled by other groups designed for use in terminal connections between the exchanges at the tandem centers, and for such other items as would not exceed an over-all

(14)

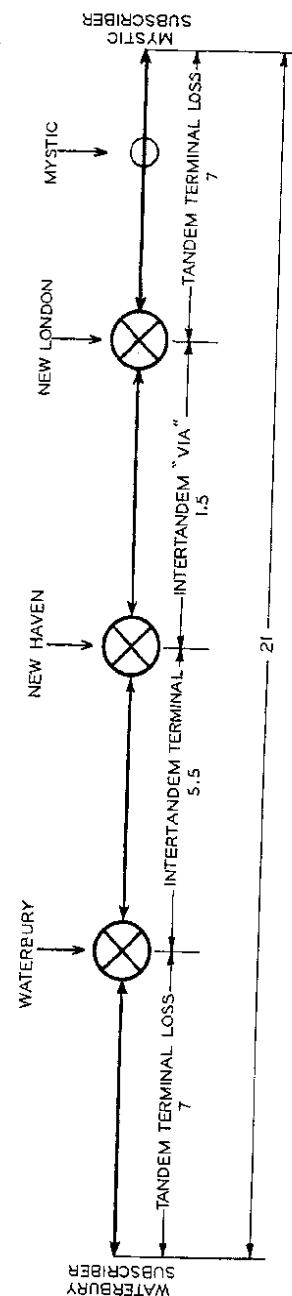
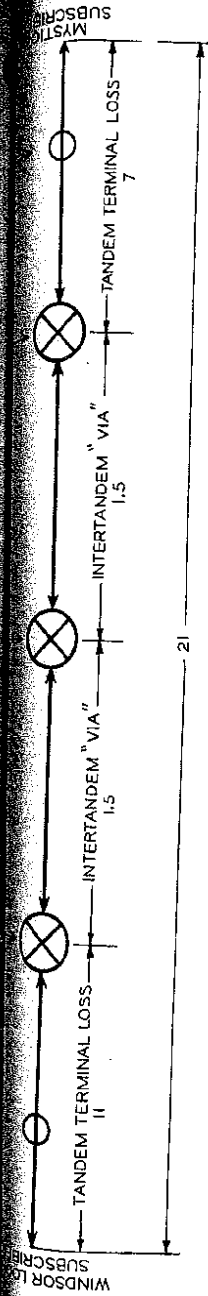

(15)

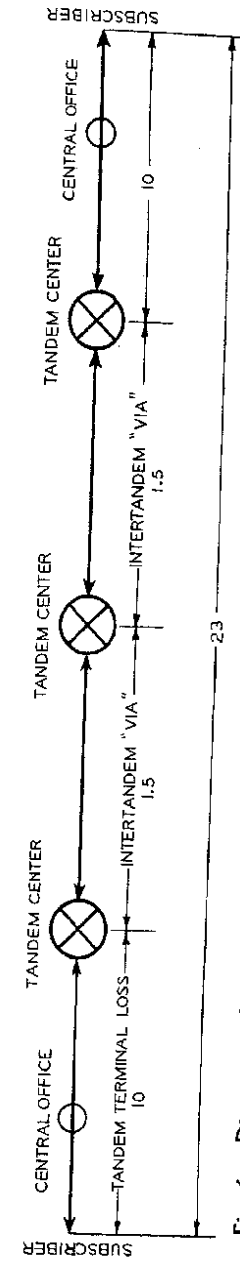

Fig. 6. Diagrams indicating normal transmission objective (bottom) and typical transmission losses (top and middle); losses are indicated in decibels

transmission loss of 23 decibels. Figure 6 indicates the normal transmission objective and several actual conditions.

A low grade "via" group consisting of 16 gauge nonrepeated cable facilities, in addition to the terminal group composed of 19 gauge nonrepeated cable facilities, was found to be economical for use between Bridgeport and New Haven in switching such traffic as would not be permitted on the 19 gauge terminal group. Each toll connection is studied individually and its routing over the tandem system is approved only if the over-all loss does not exceed 23 decibels. Since the tandem terminal loss for some exchanges at present is less than 10 decibels, it is possible to approve certain items of traffic involving 3 intertandem circuits.

Between New Haven and New London a separate terminal group of trunks cannot be justified. Instead, the "via" group, which operates at a loss of 1.5 decibels on switched connections with a terminal repeater at New Haven, is used also for terminal business. In order to prevent exceeding the allowable crosstalk level, and to provide a safe singing margin on calls involving New Haven subscribers, these circuits are made suitable for terminal traffic by the insertion of a 3 decibel pad on the drop side of the repeaters at New Haven.

It is normal practice in telephone work to use a line and equipment that provide an impedance of about 600 ohms at toll offices; however, the majority of outside facilities used in the tandem system have characteristic impedances of 1,500 ohms, and repeating coils would be necessary in many instances to match the impedances. Since much of the traffic into a tandem center is switched to points beyond its exchange area, the amount of coil equipment required for through connections is minimized by placing the impedance correcting equipment between the 1,500 ohm trunk and the subscriber lines in the local exchange at the tandem center.

It is possible that as the tandem system is extended it will be economical to use the dial-in arrangement of voice frequency repeaters to replace or supplement the terminal repeaters. The advantages of increased traffic capacity allowed by the pooling of a large number of repeaters at each of the centers, and the flexibility afforded for the various types of connections, will compensate for the lower

(16)

gains occasioned by the use of the dial-in repeaters. Undoubtedly there will be a tendency to reduce the number of different types of loading, and therefore to make possible higher gains with the dial-in repeaters because of better impedance matches between any line and the compromise networks.

EQUIPMENT ITEMS

The central office equipment of the tandem system includes selector switches, trunk terminal equipments, operators' switchboards, and voice frequency repeaters.

The selector switches known as toll preceding selectors are similar to the standard local step-by-step selectors used in dial central offices for completing local calls. Certain refinements have been made to provide a visual, as well as audible, busy signal to the originating operators and an arrangement has been introduced for compensating tandem trunks to a standard 1,200 ohm circuit to equalize the fluxes in all pulsing relays to the best condition. Calls are completed to local step-by-step offices through a train of switches designated "AB toll," consisting of toll transmission selectors, toll intermediate selectors, and connectors.⁵ Toll transmission selectors provide a means of matching impedances between tandem trunks and local subscribers' lines with a repeating coil of proper ratio and a means for supplying battery current more efficiently to subscribers' transmitters. The major functions of the toll transmission selector used for tandem completion are similar to those of a regular toll transmission selector, except that the former causes machine ringing to start immediately without awaiting a ringing signal from the originating operator. For this reason the selector has no facilities for relaying the line closure signal back to the originating operator by a reversal as in regular toll trains. The switch uses the reversal, however, to provide supervisory signals indicating the conditions of the called line, that is, busy, answered, or unanswered. The originating operator's cord supervisory lamp burns steadily when the called line is not answered, flashes 60 times a minute if the line is busy, flashes 120 times a minute if all paths through the office to the called line are busy, and is extinguished when the call is answered.

A considerable variety of trunk terminal equip-

(17)

(18)

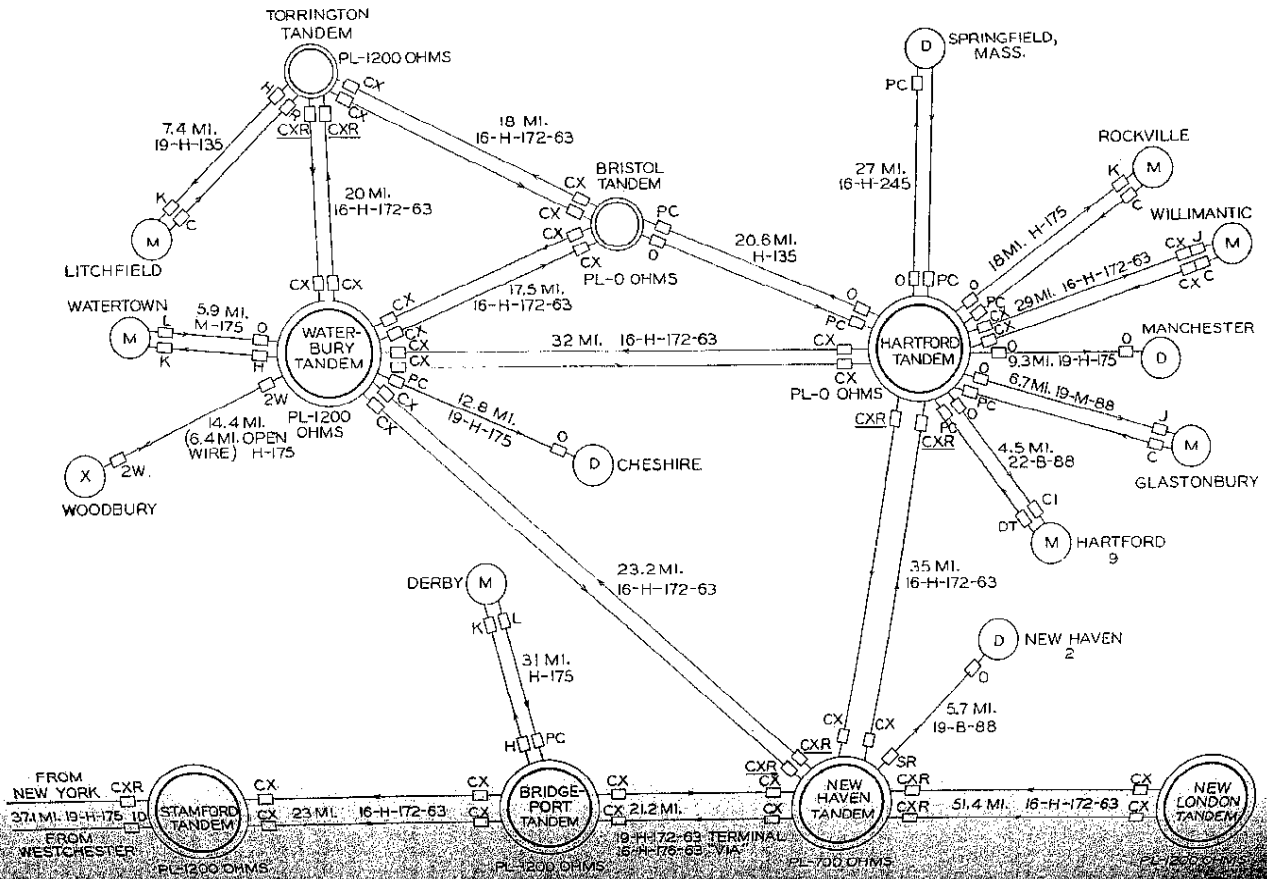

Fig. 7. Typical trunk equipment layout

(19)

- | | |
|--|---|
| ID—Intermediate dial trunk equipment | CXR—Phantom composite partially equipped with repeaters for terminal and "via" groups |
| DT—Dial key dial trunk equipment | H—Manual holding equipment |
| C—Dial cord dialing trunk equipment | CI—Call indicator trunk equipment |
| J—Jack-ended straightforward tandem completing trunk equipment | R—Compensating resistances |
| K—Cord-ended straightforward tandem completing trunk equipment | 2W—2-way equipment |
| PC—Incoming pulse correctors, 3,000 ohm range | PL—Compensated pulsing loop |
| O—No trunk equipment except selectors | D—Step-by-step dial office |
| L—Listening key dialing trunk | M—Common battery manual office |
| SR—3 wire trunk equipment | X—Magneto office |
| CX—Phantom composite equipment | Average impedance of New London tandem—900 ohms |
| CXR—Phantom composite with repeaters | Average impedance of all other tandems—1,500 ohms |

Designations on lines indicate circuit miles, gauge of cable wire, and type of loading, in that order. For example, the designation "17.5 Mi, 16-H-172-63" indicates: 17.5 circuit miles; number 16 Brown and Sharpe gauge cable wire; loading coil spacing (H) 6,000 feet (B and M indicate respectively 3,000 and 9,000 foot spacings); inductance of physical or side circuit loading coils, 172 millihenrys; and inductance of phantom circuit loading coils, 63 millihenrys. Absence of the last figure indicates that phantom circuit operation is not used.

ment is required to meet various traffic, transmission, and outside plant conditions. Some of the required features are phantom, nonphantom, loop or composite signaling, repeatered, nonrepeatered, pulse correcting, pulse repeating, one-way, and 2-way. Figure 7 indicates the actual equipment in use on various typical groups of trunks and also some of the characteristics of each tandem center. The phantom composite method has been outlined in an earlier paper.² The more recent improvements include the addition of a pulse correcting feature to the incoming and outgoing terminals of the circuit and a rearrangement of apparatus to allow the use of a relay rack unit, instead of the earlier step-by-step repeater shelf mounting.

The maximum range of circuit at present in use in this area is about 3,520 ohms external loop resistance, or about 35 miles of 19 gauge cable. The longest single link in the system is that between New Haven and New London, a wire distance of about 52 miles, and it has a loop resistance of approximately 2,600 ohms. The development of phantom composite signaling circuits having nearly twice the former range has been completed. These newer circuits may prove economical in combination with smaller gauge conductors and one or more voice frequency repeaters where facility conditions are suitable. The arrangement of apparatus in this circuit more nearly resembles that of the standard ringdown toll circuit terminal equipment by use of separate units for composite sets, phantom sets, composite signaling sets, and auxiliary relay equipment units.

The use of voice frequency repeaters on tandem circuits requires certain circuit arrangements, the most important of which is composite signaling. Since the vacuum tube device must be insulated from direct signaling current, repeating coils are provided in both the physical and artificial lines of the set. Repeating coils block any form of direct signaling current, but the phantom composite signaling circuit provides a method of signaling around repeating coils, and is therefore used whenever voice frequency repeaters are required. Phantom composite sets are universally wired so that they may be arranged for use with or without voice frequency repeaters. Where cable facilities that are not suitable for phantom operation must be

(20)

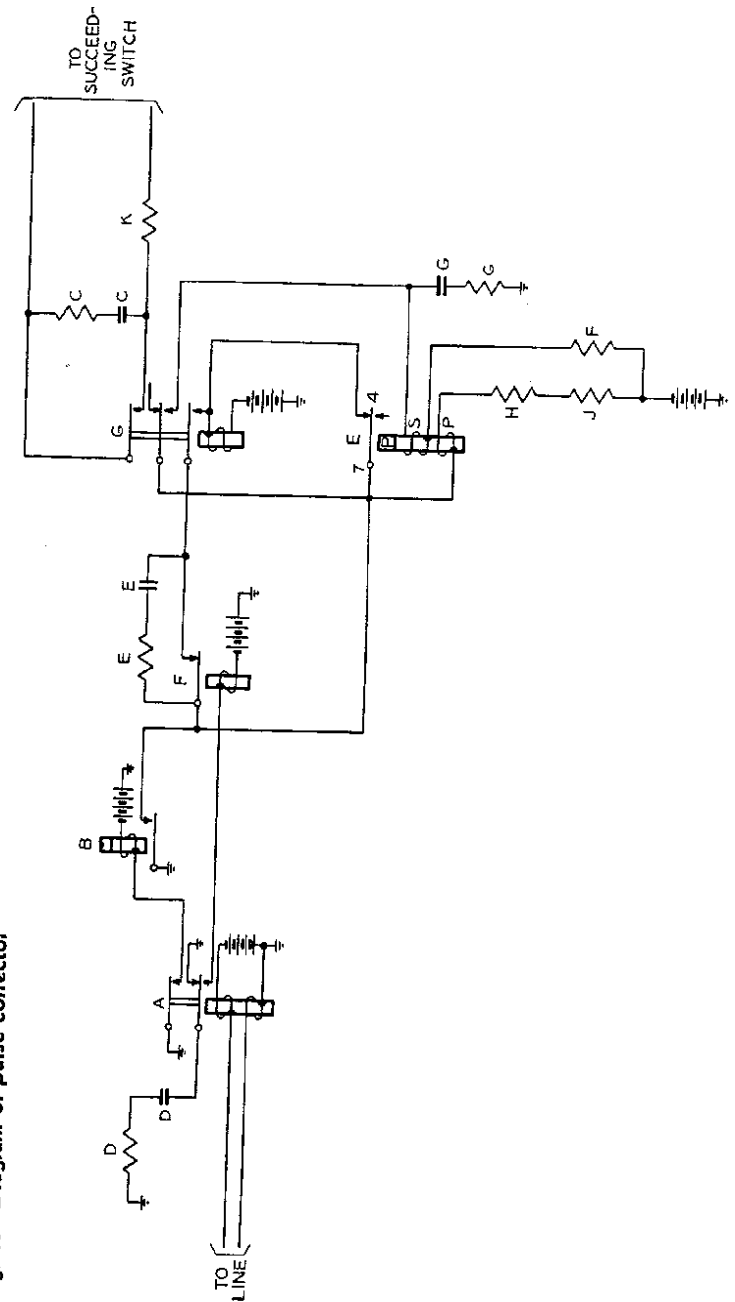

Fig. 8. Diagram of pulse corrector

(21)

used, the phantom composite unit can be modified so that the equipment normally used for the phantom trunk is connected directly to a third pair between offices instead of to the middle point of the side circuit repeating coils. This arrangement is in use between the New York suburban tandem office and Stamford, since nonquadded facilities only are available in a short section of the route. Quadded cable later will permit conversion to the more efficient phantom operation by a minor wiring change at each terminal. In order to avoid singing, and still obtain maximum gain, the voice frequency repeaters must be adjusted for best balance with circuits in the talking position. Since there may be unbalances in the idle and pulsing positions, the phantom composite circuits are arranged for idle termination of both line and artificial line in a resistive and capacitive network. The use of well balanced repeating coils of precise impedance ratio is required with voice frequency repeaters.

The most common type of pulse repeater used in both local systems and earlier tandem service is that in which the pulses received by the line relay are reproduced by its contacts and transmitted to succeeding circuits in the train. This type of transmission is subject to distortion caused by the time characteristics of the relay and the electrical properties of the line facility. Although the total distortion is not serious in a single repetition, the cumulative distortion in several links would exceed the tolerance of the terminating switches and result in wrong selections. To overcome this difficulty a pulse correcting repeater has been developed, which provides a signal of constant length so far as the open period of the pulse cycle is concerned, without regard to the length of signal received.⁶

Figure 8 represents the pulse correcting feature of both loop and composite signaling equipments. During the pulsing interval, the repeater produces outgoing signals approximately one cycle behind the incoming signals. As pulses are received from a preceding circuit they are followed by relay *A*. When relay *A* releases on the open portion of the pulse, the capacitor *D* is discharged. When relay *A* reoperates on closure of the pulse, relay *F* operates momentarily on the charging circuit of capacitor *D* and releases relay *G*. Relay *G*, being released, opens the bridge to the succeeding circuit and removes

(22)

ground from the secondary winding of relay *E*. The current continues through the secondary winding of relay *E* to charge capacitor *G*, but this current gradually diminishes as the capacitor becomes charged. The flux through the secondary winding diminishes gradually until it is less than the flux of the primary winding, and at that time the relay closes contacts 4 and 7. This reoperates relay *G*, which again closes the bridge to the succeeding circuit. The resistors and capacitors associated with relay *E* are chosen to provide the time for its release, and in turn the time for the release of relay *G*, that will give the proper open period to pulse the succeeding switches regardless of the open period received by relay *A* of this circuit during pulsing.

One feature of most trunk equipments is the provision of a ground on the sleeve circuit of trunks to or from selectors to provide the busy condition for the trunk and a holding circuit for all selectors in the operated position on any particular call. In any one tandem office it is necessary to determine whether the holding grounds should be provided by equipments on each outgoing circuit, or whether a smaller amount of equipment, usually pulse correcting repeaters, will provide a holding ground on each incoming circuit, thus making outgoing equipment unnecessary except for phantoming purposes. In the Hartford, Bristol, and Stamford tandem offices the later arrangement has been the most economical due to the excess of outgoing over incoming trunks. The outgoing holding equipment for trunks to manual offices is a comparatively inexpensive 2-relay circuit.

Switchboards in dial exchange areas are equipped with dials operated on a dial key or listening key basis, whereas in manual areas the operator's dial is associated with the tandem dial trunk by the dial cord method.

The equipment provided at manual switchboards for outgoing trunks to tandem is identical with that which would be used on circuits to a local step-by-step office in the same exchange area. Where phantom operation is desirable, a standard phantom composite unit originally designed for installation in step-by-step offices is provided at the manual office and inserted between the usual out-dial trunk equipment and the cable facility. The trunks from Willimantic to Hartford and from East Hampton to Hartford are examples of this arrangement.

(23)

The tandem completing trunk equipments in the various manual offices have the common characteristic of providing switchhook supervision to the originating operator, but differ otherwise in accordance with the design and traffic requirements of the particular board. Manual offices in a multiunit exchange having some dial equipment normally are provided with call indicator equipment, and tandem calls are completed over these call indicator trunks. In other manual switchboards, jack ended and cord ended completing trunks have been installed for tandem use. The calls on jack ended trunks are completed by the use of local cords that are modified to provide through supervision on tandem calls. The cord ended trunks usually are answered by the operation of a listening key, but they may be connected to the operator automatically. All straightforward trunks provide an order tone to the originating operator when the completing operator is ready to receive the details of the call.

In magneto offices it is not practicable to provide a signal to indicate the answer by the called party; therefore, it is necessary for the magneto operator to monitor until the start of conversation, then operate a charge key associated with the incoming trunk to retire the supervisory lamp at the originating switchboard.

The power supply requirements at tandem centers do not differ from those of ordinary step-by-step dial local offices that use a battery, the voltage of which is held between the limits of 45 and 50. In manual offices the battery voltages ordinarily provided have proved satisfactory even for composite signaling circuits requiring a 48 volt battery of not more than 5 volts variation.

SUMMARY

The dial tandem method of handling interexchange telephone traffic in Connecticut, introduced as an adjunct of the comprehensive dial conversion program, has been developed to take a major place in the handling of toll traffic. The use of the tandem method affords a definite improvement over the earlier methods in speed and accuracy of service to the subscriber, in simple and more uniform operating practices, and in reduction in operating effort. The facility of disposal of toll calls over this system by

local operators without measurable interference with regular local traffic has contributed greatly to the success of the method of accepting all station-to-station toll calls at local boards. A more uniform transmission plan for the telephone plant is possible now, and a flexible relationship between traffic, trunk terminal and switchboard equipment, and inter-exchange wire plant has resulted in economies of operation.

The present experience with the dial tandem method indicates the desirability of extending this method to the other exchanges of the state as soon as it can be done economically.

REFERENCES

1. TANDEM OPERATION IN THE BELL SYSTEM, F. M. Bronson. *Bell System Tech. J.*, v. 15, July 1936.
2. TANDEM SYSTEM OF HANDLING SHORT HAUL TOLL CALLS IN AND ABOUT LOS ANGELES, F. C. Wheelock and E. Jacobson. *A.I.E.E. TRANS.*, v. 46, Jan. 1928, p. 9-22.
3. STRAIGHTFORWARD TRUNKING, W. C. Oakes. *Bell Lab. Record*, v. 7, April 1929, p. 323-26.
4. AN OUTLINE OF STEP-BY-STEP OPERATION, E. D. Butz. *Bell Lab. Record*, v. 8, December 1929, p. 174-77.
5. THE TOLL TRAIN, E. D. Butz. *Bell Lab. Record*, v. 10, December 1931, p. 131-34.
6. THE PULSE CORRECTOR, R. C. Paine, *Bell Lab. Record*, v. 7, May 1929, p. 361-64.